



DISPLAY 9000

Dekorative Nothinweisleuchte
aus hochwertigem Edelstahl
in LED-Technik

24m

DISPLAY 9000	EVG-Version	Akku-Version	Optional
ERKENNUNGSWEITE / viewing distance	24m		<ul style="list-style-type: none"> Betoneingießtopf / concrete ceiling box <p>DG6_BET</p>
GEHÄUSEMATERIAL / housing material	Edelstahl / stainless steel		
OBERFLÄCHE / surface	gebürstet / brushed		
LEUCHTMITTEL / illuminant	LED		
LEISTUNG (AC/DC) / load (AC/DC)	5,9VA / 2,8W	–	
SPANNUNG / voltage	230V AC/DC	230V AC	
NiMH-AKKU / NiMH-battery	–	4,8V - 0,8Ah	
LICHT (Netz/Not) / luminous (mains/emergency)	100%	50%	
SCHUTZART / protection category	IP 41		
SCHUTZKLASSE / protection class	I		
ARTIKELNUMMER / article number	D90		

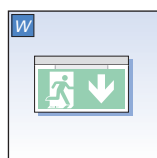

Wandmontage
wall mounting

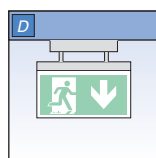

Deckenmontage
ceiling mounting

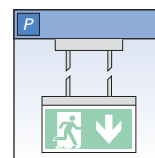

Pendelmontage
pendulum mounting

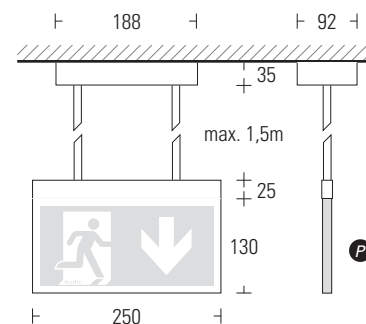
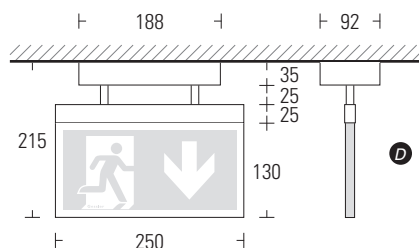
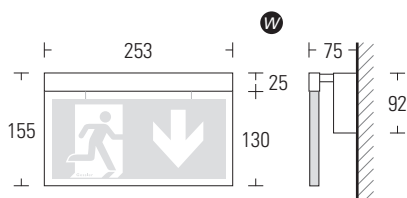

EVG-Version				Akku-Version				
ohne Überwachung without monitoring	mit Überwachung with monitoring	DALI-Überwachung DALI-monitoring	Kino-Ausführung Theatre version <small>neu</small>	1h	3h	8h	Auto-Check auto-test	BUS-Check BUS-test
•	•	•	• <small>Lichtstrom im Netzbetrieb 10%</small>	•	•	–	•	•

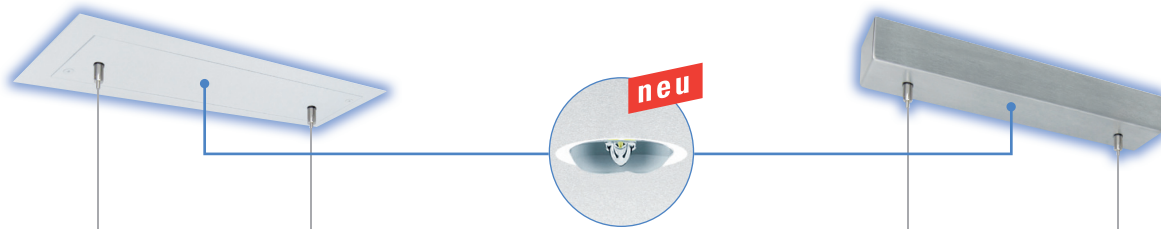

Optional:
 Mit integrierter Bereitschaftsleuchte.
 Lichttechnik identisch mit LED-Spot LA5

DESIGN PLUS

participate 2012



Besonderheit:
 Spannungsversorgung über
 Seilabhängung

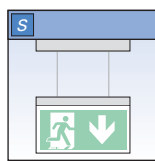
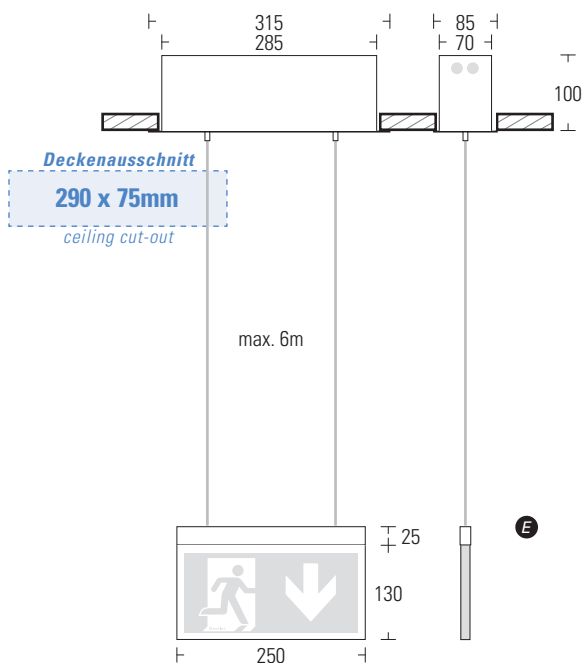

Seillaufbau
 rope mounting

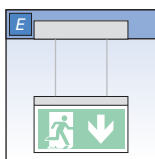

Seileinbau
 recessed rope mounting

